

# Kabelkanäle MS 40+

## Cable ducts MS 40+

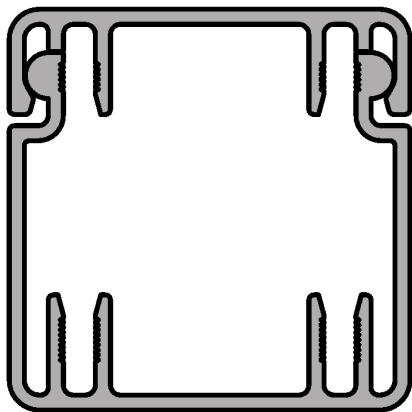

Aluminium-Kabelkanäle zur Verlegung von Kabeln und Schläuchen. Einfach auf bestehende Konstruktion verschrauben und Abdeckprofil aufclipsen.

### Vorteile:

- Einheitliche Optik in Verbindung mit Aluminium-Gestellen
- Gleiches Rastermaß wie die Profilbaureihe MS 40+
- Einfache Montage und Handhabung

Aluminium cable duct for your cabling and piping. Simply screw onto existing design and click on the covering profile.





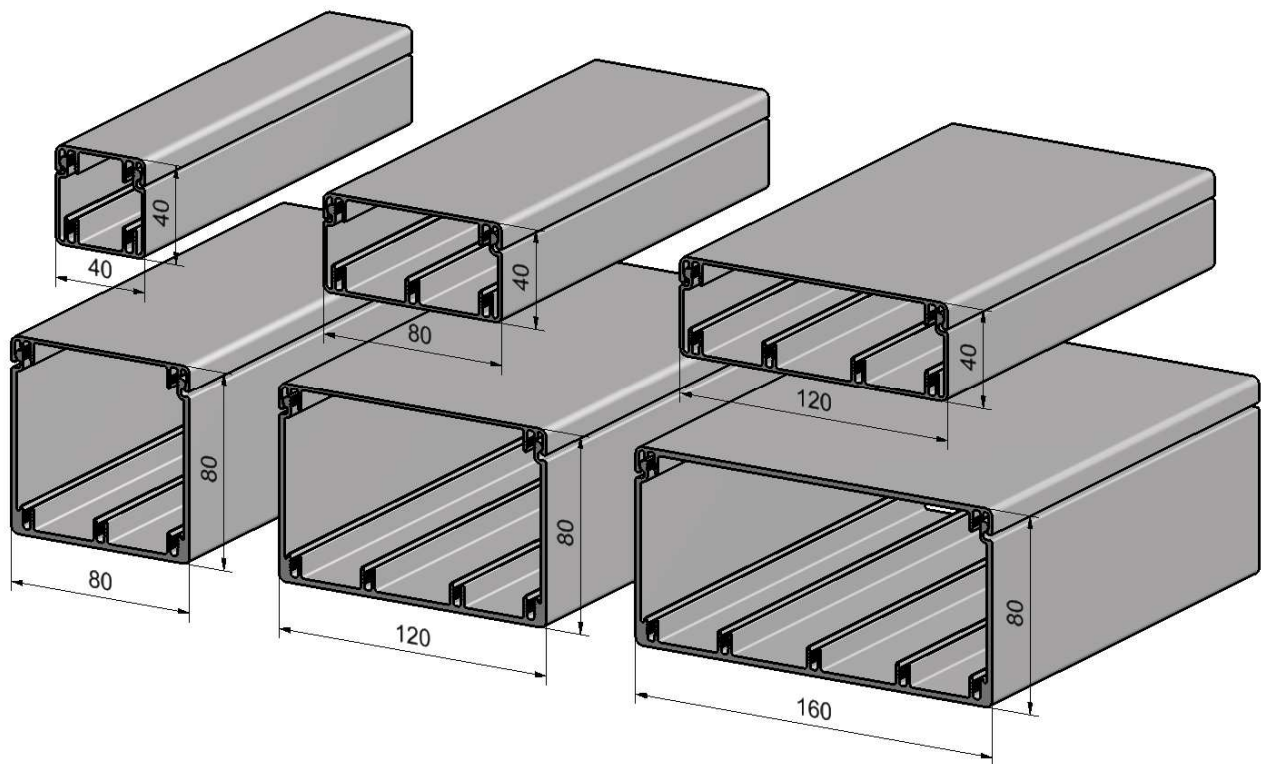







### Advantages:

- uniform appearance in combination with aluminium frameworks
- same spacing as the profile series MS 40+
- simple assembly and handling

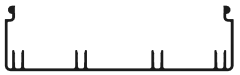
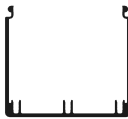

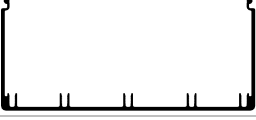
# Kabelkanäle MS 40+

## Cable ducts MS 40+

		Art.-Nr. Prod.-no.				
m						Kg/m
	Kabelkanal MS 40+ 40x40 Cable duct MS 40+ 40x40	3 <b>400 023</b>	<b>924 968</b>	Al	E6/EV1	0,7
	Kabelkanal MS 40+ 40x80 Cable duct MS 40+ 40x80	3 <b>400 024</b>	<b>924 968</b>	Al	E6/EV1	0,9
	Kabelkanal MS 40+ 40x120 Cable duct MS 40+ 40x120	3 <b>400 025</b>	<b>924 969</b>	Al	E6/EV1	1,15
	Kabelkanal MS 40+ 80x80 Cable duct MS 40+ 80x80	3 <b>400 026</b>	<b>924 969</b>	Al	E6/EV1	1,8
	Kabelkanal MS 40+ 80x120 Cable duct MS 40+ 80x120	3 <b>400 027</b>	<b>924 970</b>	Al	E6/EV1	2,1
	Kabelkanal MS 40+ 80x160 Cable duct MS 40+ 80x160	3 <b>400 028</b>	<b>924 970</b>	Al	E6/EV1	2,4
	Kabelkanal Abdeckung MS 40+ 40 mm Cable duct cover MS 40+ 40 mm	3 <b>400 029</b>	<b>924 968</b>	Al	E6/EV1	0,3
	Kabelkanal Abdeckung MS 40+ 80 mm Cable duct cover MS 40+ 80 mm	3 <b>400 030</b>	<b>924 968</b>	Al	E6/EV1	0,5
	Kabelkanal Abdeckung MS 40+ 120 mm Cable duct cover MS 40+ 80 mm	3 <b>400 031</b>	<b>924 970</b>	Al	E6/EV1	0,7
	Kabelkanal Abdeckung MS 40+ 160 mm Cable duct cover MS 40+ 80 mm	3 <b>400 032</b>	<b>924 970</b>	Al	E6/EV1	1,2

**MS Plus Automation**  
Höfeweg 62 a  
33619 Bielefeld  
Tel: +49 521 304 30-0  
Fax: +49 521 304 30-153  
info@msplusautomation.com  
www.msplusautomation.com

**MS<sup>+</sup>AUTOMATION®**